

Zoom Backpack Flag

ZOOM-BKPK

The Zoom Backpack flag is a great way to promote and advertise while on the move. It is ideal for walking promotion and advertising, lightweight, sturdy and can be used with four different types of flag types/shapes – teardrop, feather, rectangle and X-banner style.

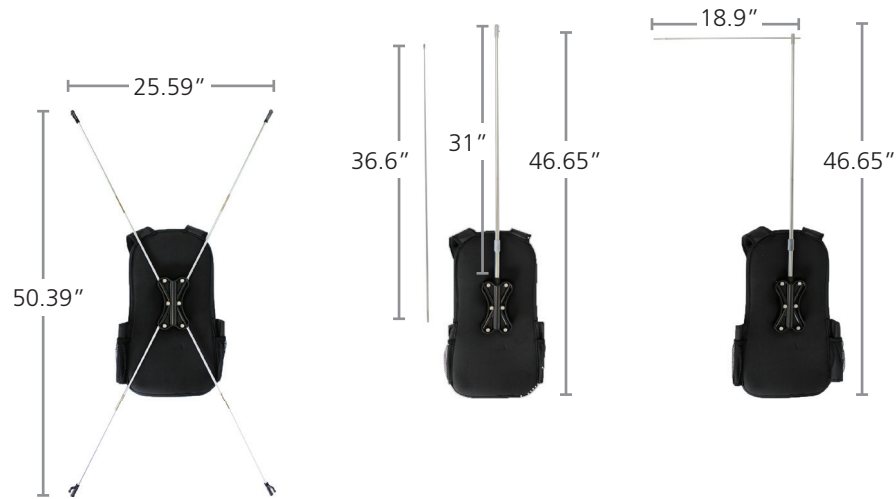

We are continually improving and modifying our product range and reserve the right to vary the specifications without prior notice. All dimensions and weights quoted are approximate and we accept no responsibility for variance. E&OE. See Graphic Templates for graphic bleed specifications.

features and benefits:

- Poles and rods that support every style flag; all fit within backpack
- Flag mounting system
- Reinforced straps
- Adjustable belt
- Comfortable padding
- Mesh side-pockets and a zipped compartment for additional storage
- Made from coated nylon
- One year limited hardware warranty against manufacturers defects
- Six months graphic limited warranty

dimensions:

Hardware

Assembled unit:
Backpack: 12.2" w x 21.25" h x 3.15" d

Backpack with poles (no graphic):
X-Banner: 25.59" w x 50.39" h
Feather & Teardrop: 12.2" w x 46.65" h
Straight: 12.2" w x 46.65" h

Hardware weight:
3 lbs / 1.36 kgs

Shipping

Shipping dimensions:
24" l x 14" h x 14" d
610mm(l) x 356mm(h) x 356mm(d)

Shipping weight (hardware only):
5 lbs / 2.27 kgs

Graphic

Refer to related graphic template for more information.

Visit:
www.exhibitors-handbook.com/graphic-templates

additional information:

Recommended substrate: flag;
street banner- on Outdoor Scrim

X-BANNER

Parts Included:

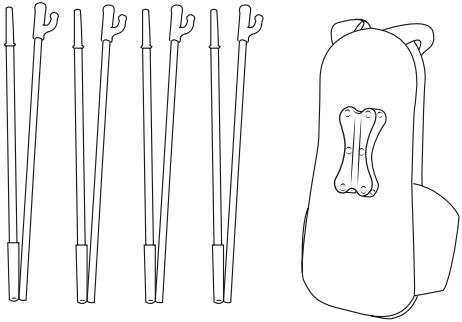

Set-up:

Step 1

- Remove hooked bungee poles from backpack.
- Extend hooked bungee poles.

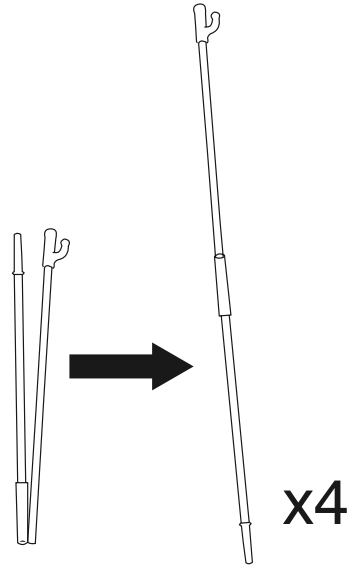

Step 2

- Insert hooked bungee poles into pole holder on backpack.

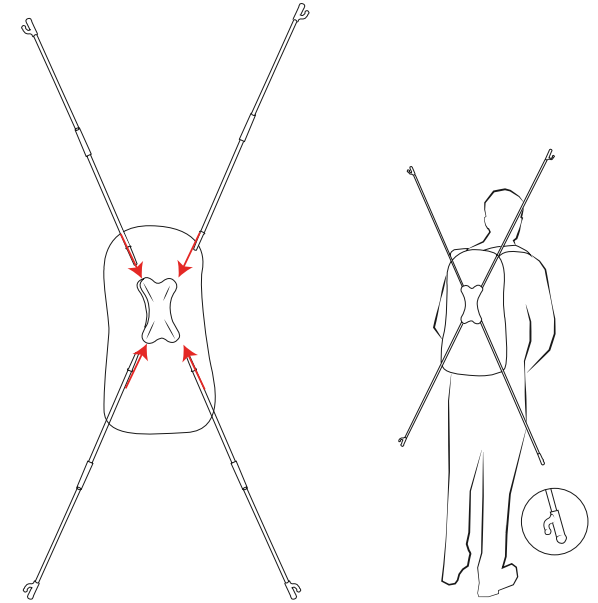

Step 3

- Apply corner grommet to hooked bungee pole. Start at bottom, finish at top.

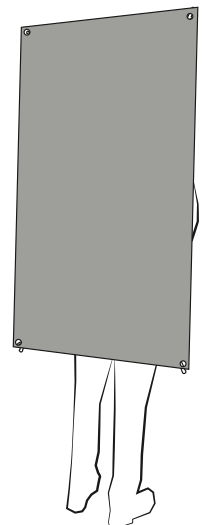
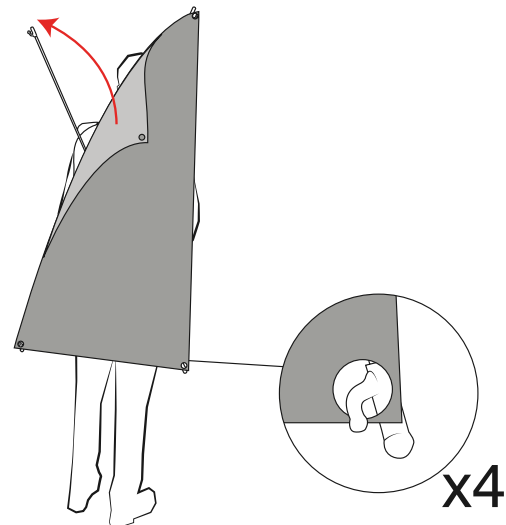

FEATHER / TEARDROP

Parts Included:

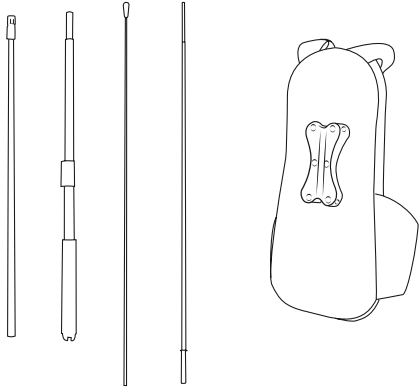

Set-up: Step 1

- Remove flag poles from backpack.
- Assemble all 4 flag poles as shown.

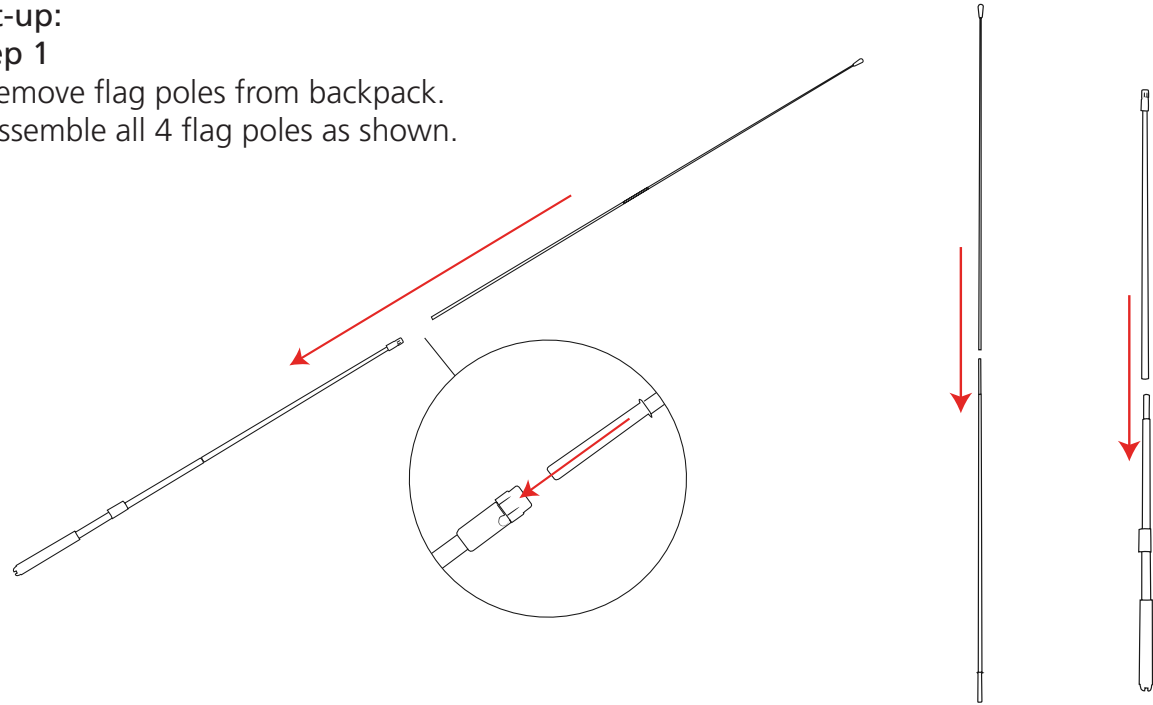

Step 2

- Insert flag poles into pole pocket on the flag graphic.

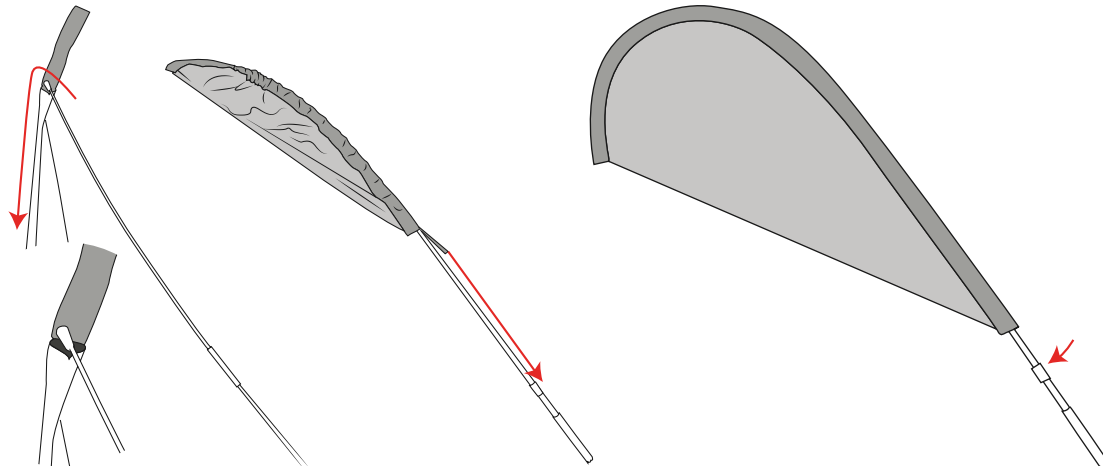

Step 3

- Secure flag graphic with Velcro at bottom of flag pole.
- Insert flag into pole holder on backpack.

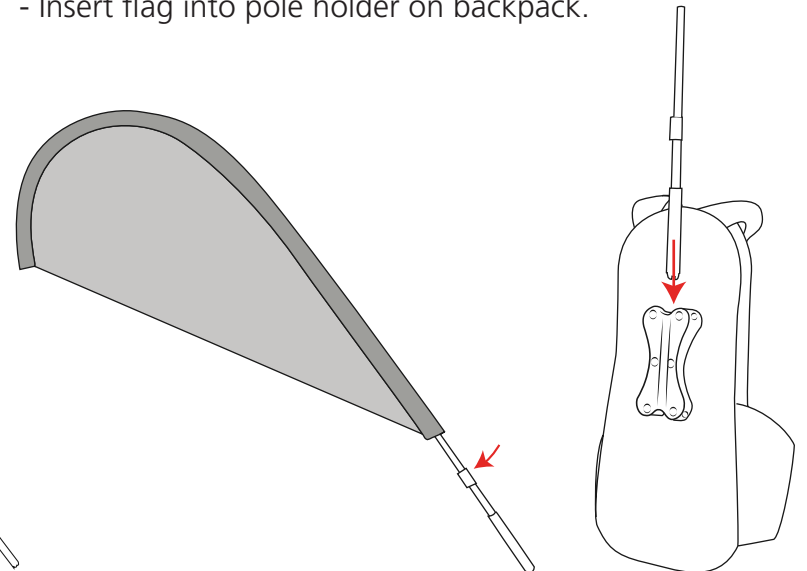

STRAIGHT

Parts Included:

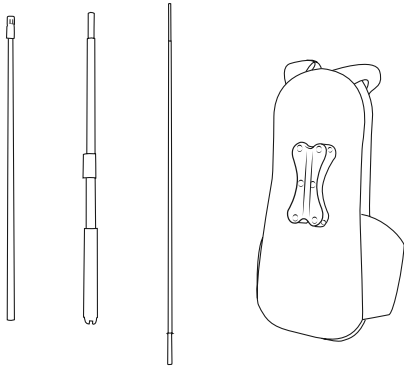

Set-up:

Step 1

- Remove flag poles from backpack.
- Assemble first two flag poles as shown.

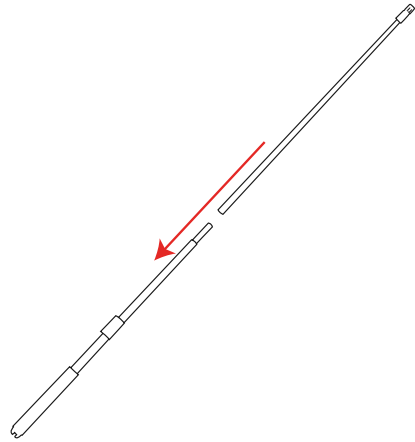

Step 2

- Insert assembled pole into side pole pocket on graphic.
- Unscrew cap on pole in the side pole pocket.

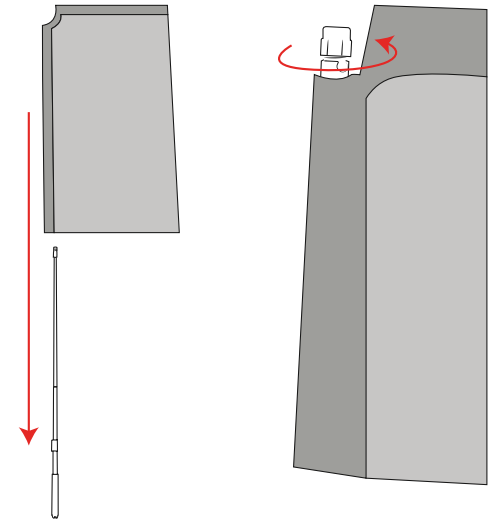

Step 3

- Insert third pole through top of assembled pole and thread through top pole pocket on graphic.
- Tighten cap back onto pole.

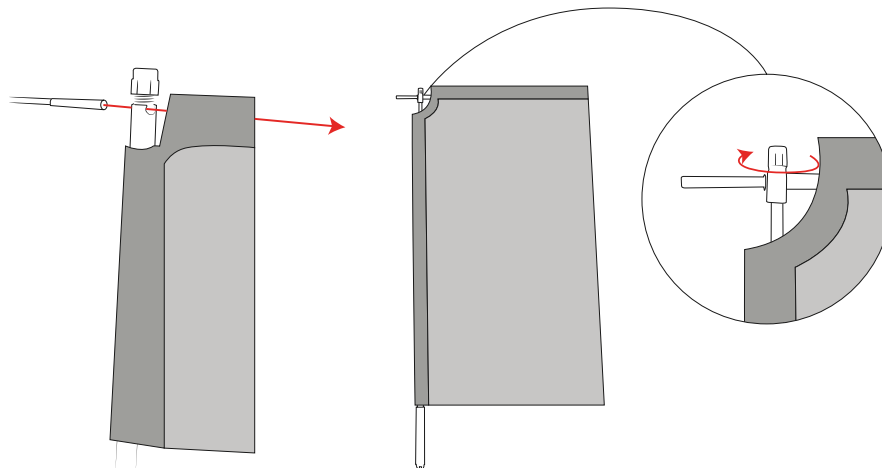

Step 4

- Insert flag into pole holder on backpack.

