

Side View

Plan View

Steps:

- 1) Slide infill between stand verticals as shown.
- 2) Attach horizontal [2] between stand verticals.
- 3) Attach base [1] to stand verticals using bolts.
- 4) Attach square plate [3] to stand using bolt.
- 5) Attach clamshell [4] to square plate [3] using hex nuts.
- 6) Insert iPad and feed wire through hole.
- 7) Attach pamphlet trays to stand. Refer to detail.

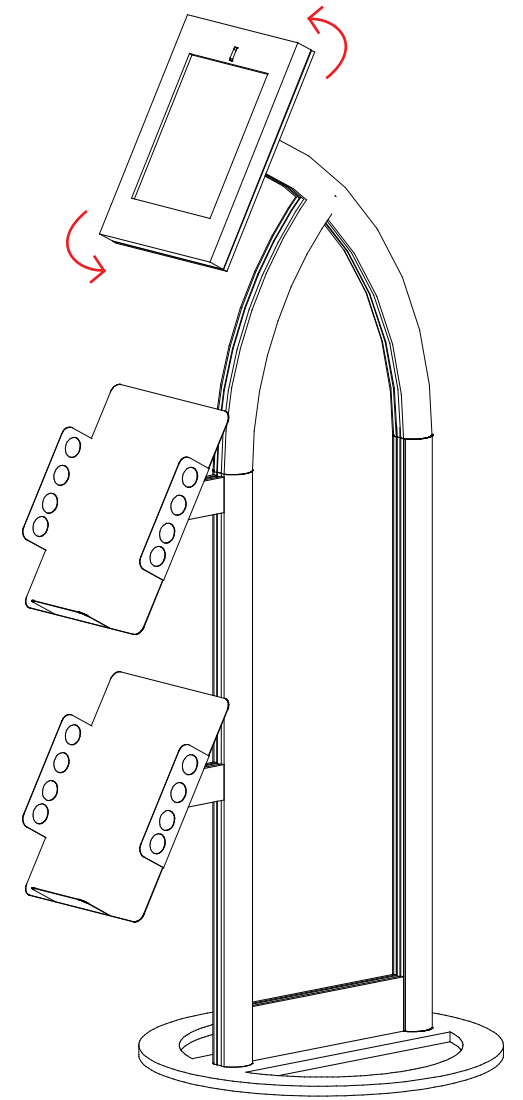
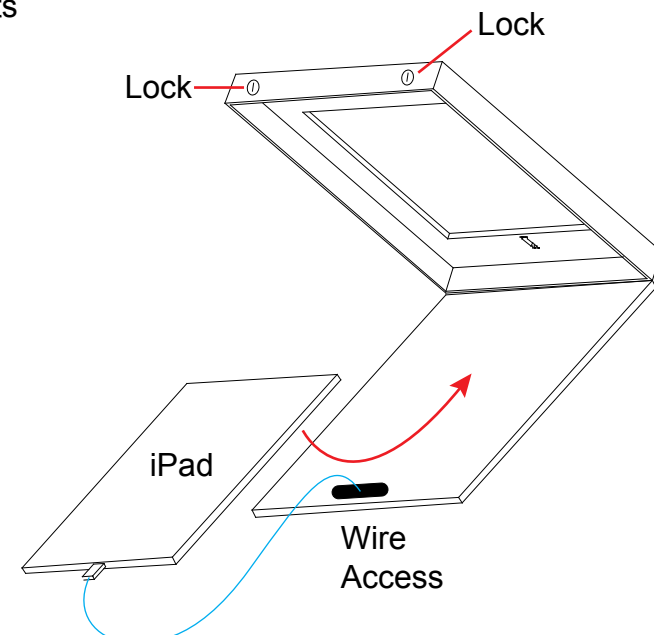
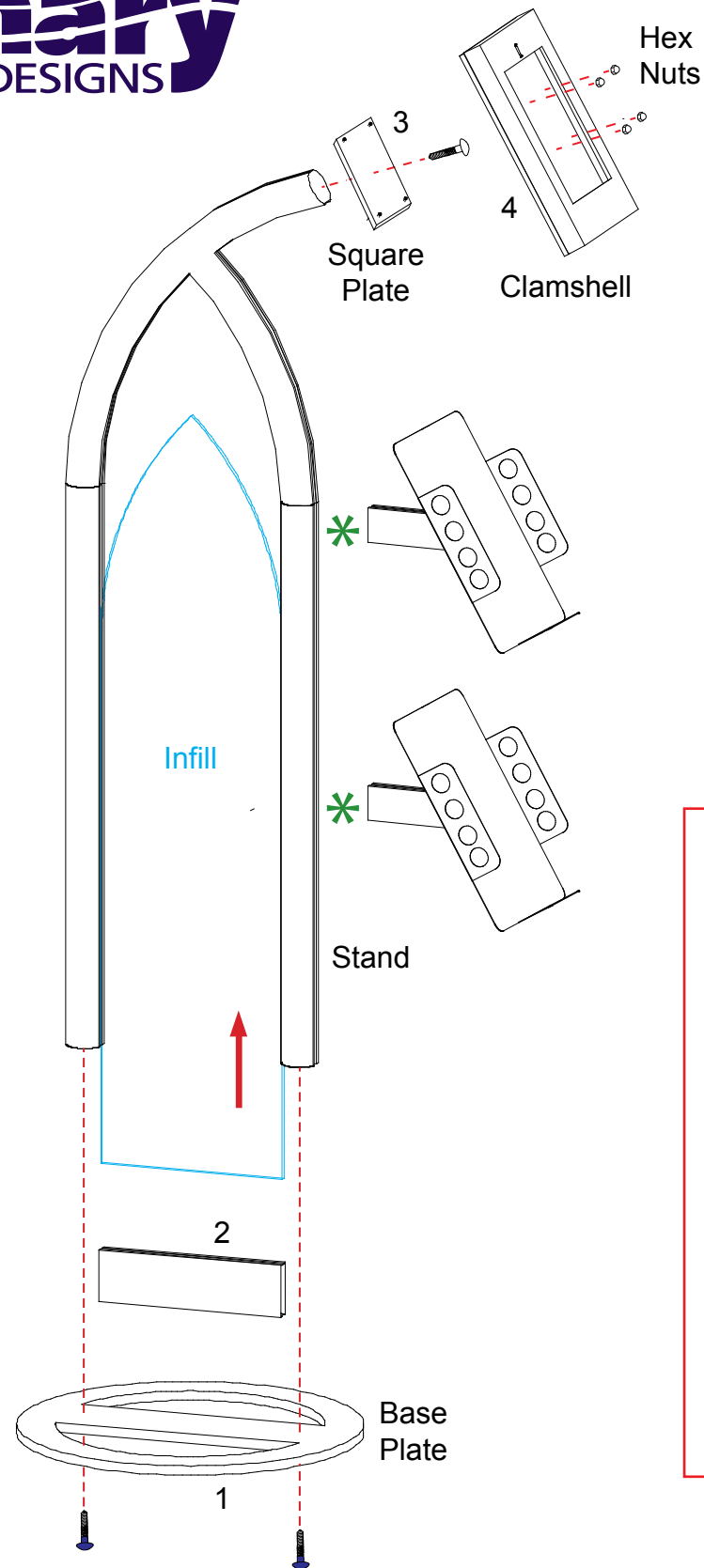

When assembled

Optional Cover for Home Button

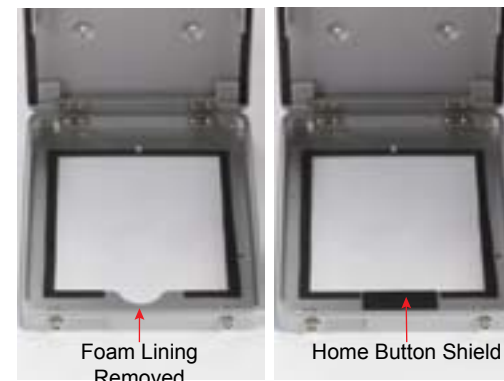

- 1) Remove foam lining from inside bottom of clamshell as shown.
 - 2) Attach Home Button Shield with double-sided tape to inside of clamshell, keeping top of shield flush with clamshell opening as shown.
- NOTE:** This is a permanent fix and can't be easily removed.

- Tools Required:
- 1) Hex Tool
 - 2) Pliers

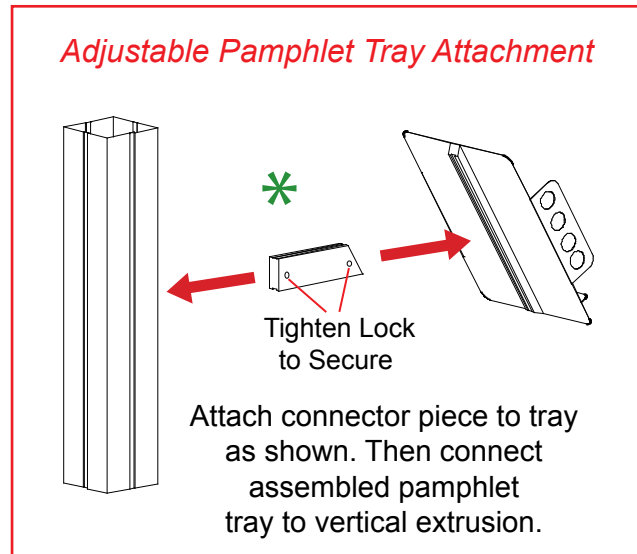

WHEN DISASSEMBLING, TIGHTEN ALL SCREWS AND NUTS TO PREVENT LOSS DURING SHIPPING.

Top View of Each Level

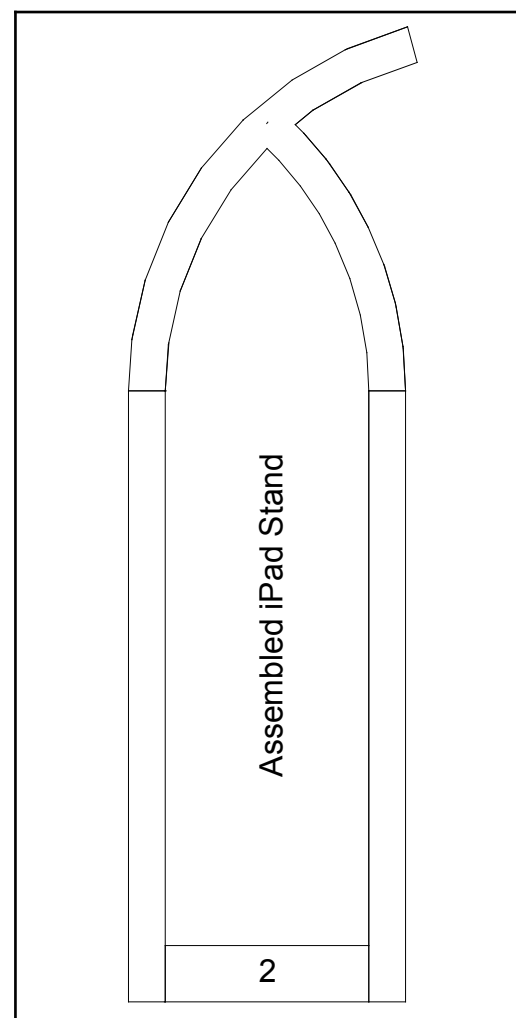

Level 1

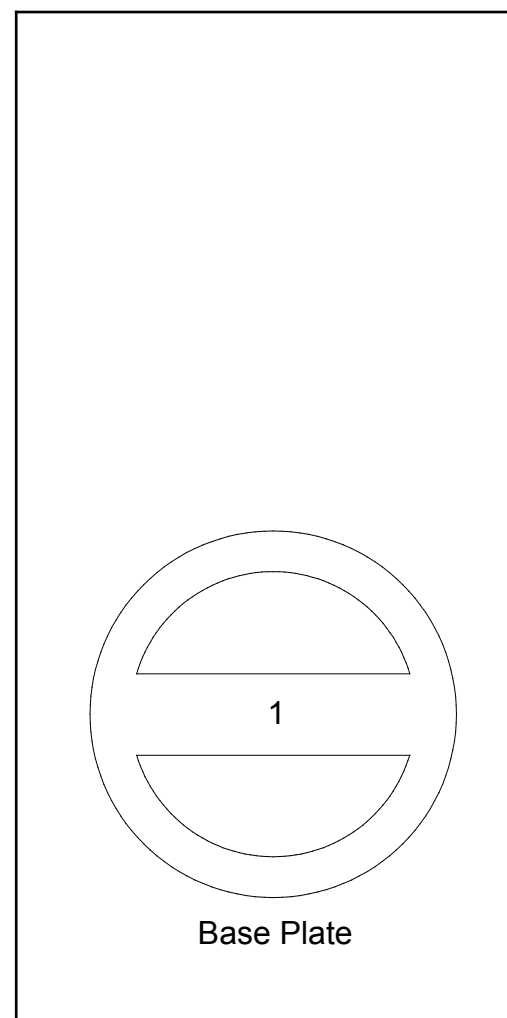

Level 2

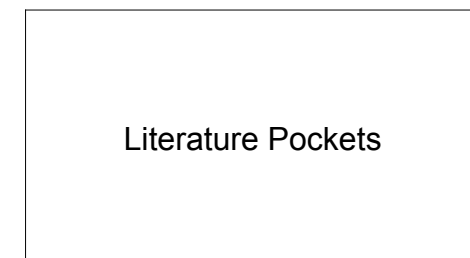

WHEN DISASSEMBLING, TIGHTEN ALL SCREWS AND NUTS TO PREVENT LOSS DURING SHIPPING.