

LUMIWALL (20'W x 8'H)

ASSEMBLY INSTRUCTIONS

CLIENT:
ORDER:
INSTR: LW-208-INSTR

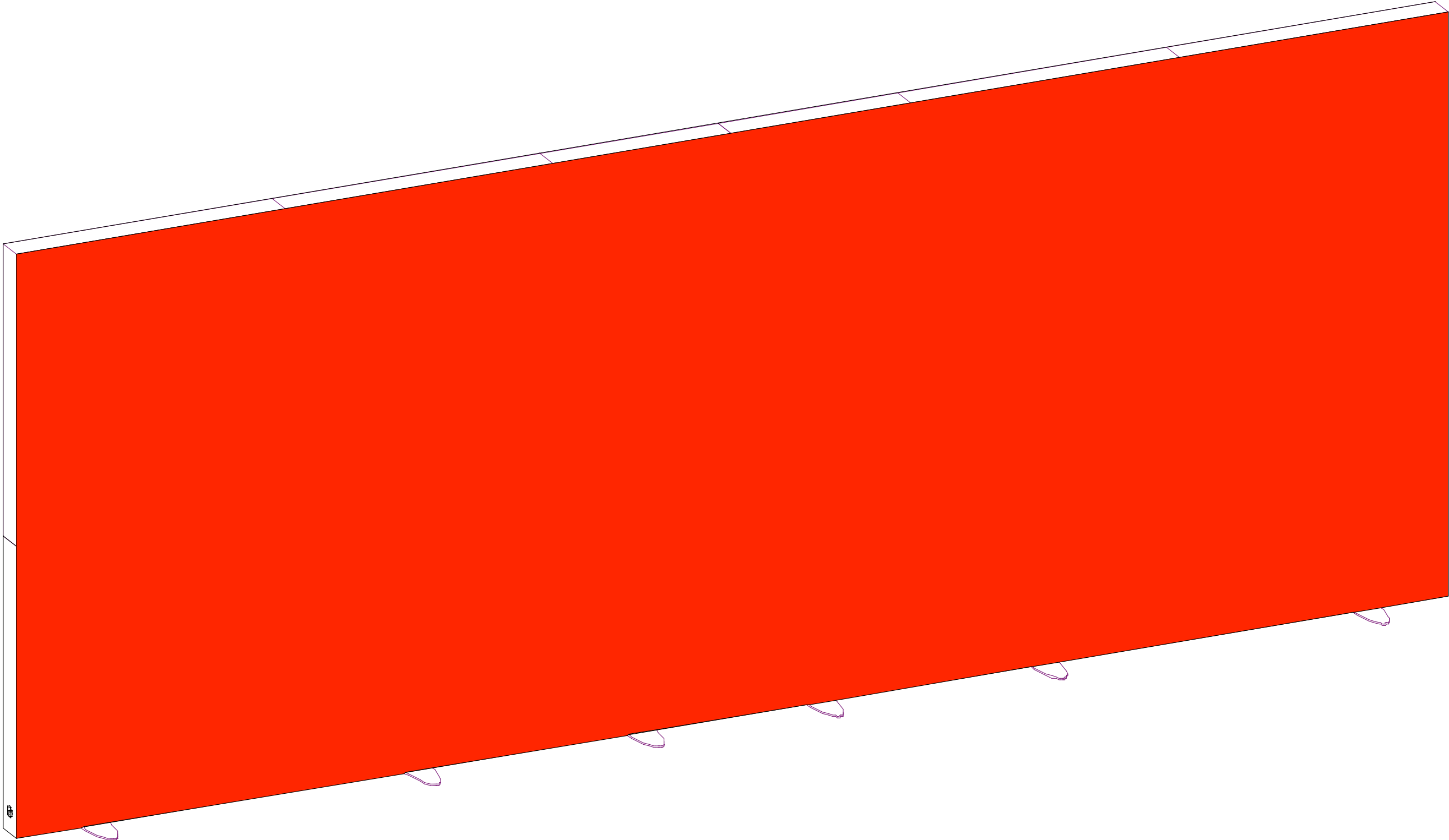

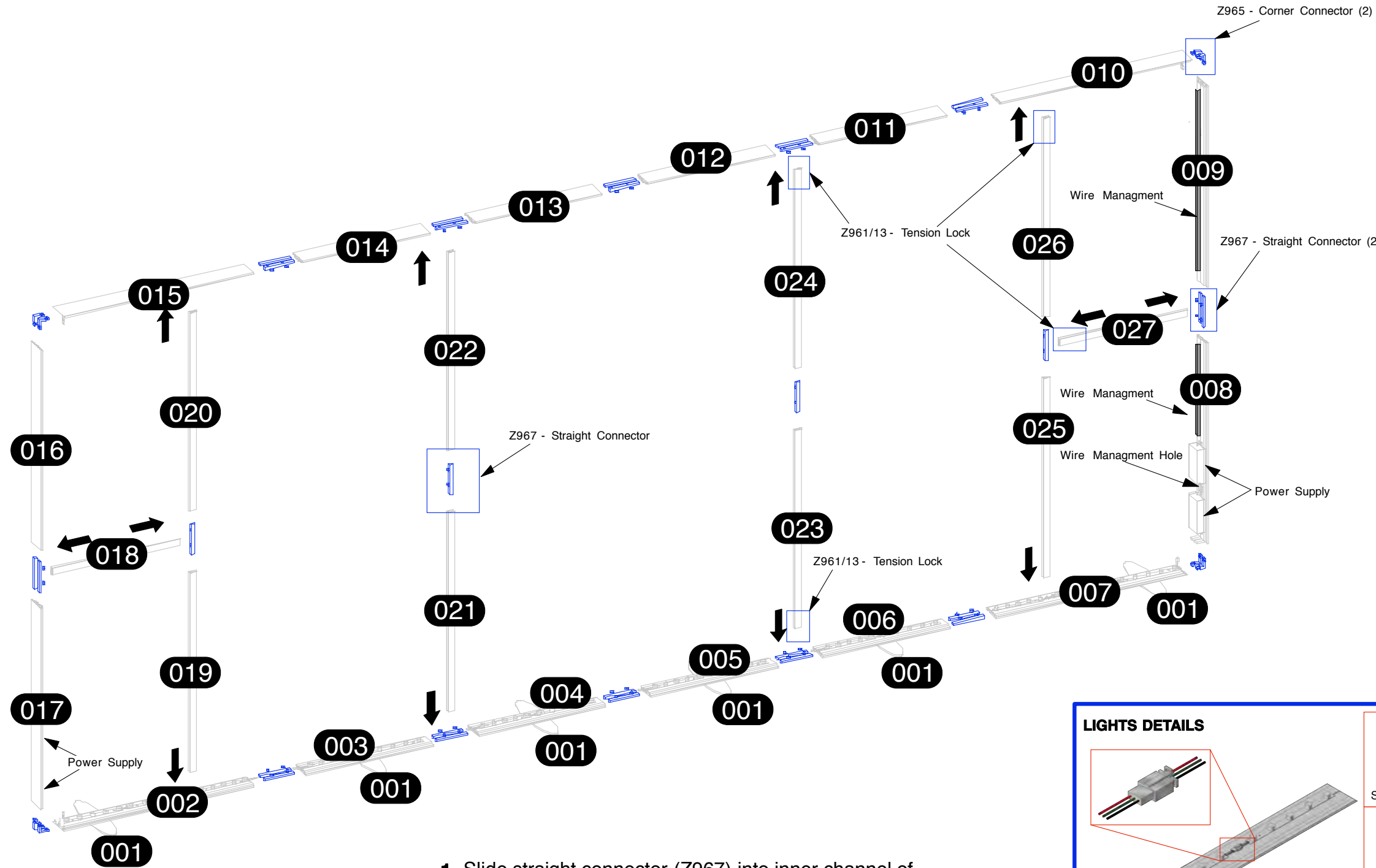

1. Slide straight connector (Z967) into inner channel of extrusion. Turn screw enough to hold connector in place.
2. Take another extrusion and slide onto straight connector. Tighten both screws to connect extrusions together.
3. Repeat above steps to connect all spliced extrusions together.
4. Slide corner connector (Z966) into both sides of horizontal extrusions. Turn each screw enough to hold connector in place.
5. Slide vertical extrusions onto corner connectors of top horizontal extrusion. Turn each screw enough to hold connector in place.
6. Finish frame assembly by sliding corner connectors of bottom horizontal extrusion into inner channel of vertical extrusions and tighten the screws to secure frame extrusions together.

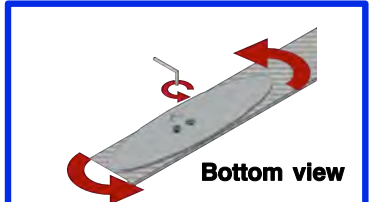

Loosen the screws on base plate but do not remove them. Then swivel base plates.

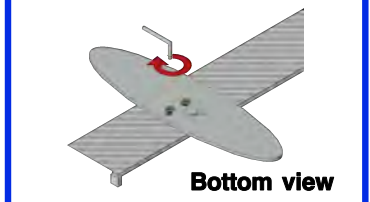

Tighten both screw firmly.

Z965 - Corner Connector

Connect frame extrusions together, as shown, using Torx tool (included). Do not overtighten.

NOTE: Remove corner connectors from extrusions before packing

Z967 - Straight Connector

Connect frame spliced extrusions together, as shown, using Torx tool (included). Do not overtighten.

NOTE: Remove connectors from beams before packing

Z967 - Straight Connector

Connect frame spliced extrusions together, as shown, using Torx tool (included). Do not overtighten.

NOTE: Remove connectors from beams before packing

Z961/13 - Tension Lock

Place tension lock into groove. Insert Torx 30 wrench and turn 1/2 turn

Tension Lock
Torx Tool

LIGHTS DETAILS

Strip-To-Power Cord

EXtension Cord 12ft

Lights come attached to extrusions. Ensure all lighting strips are connected. Once frame is assembled, connect strip-to-power cords to the end of top and bottom lights chain.

- For bottom lights connect strip-to-power cord to power supply directly.
- For top lights connect extension cord to strip-to-power cord and run with wire management extrusion then connect to power supply.

Run AC power cord out through grommet hole on vertical upright and connect to power outlet.

To remove or re-attach light strips use provided thumbscrews with plate.

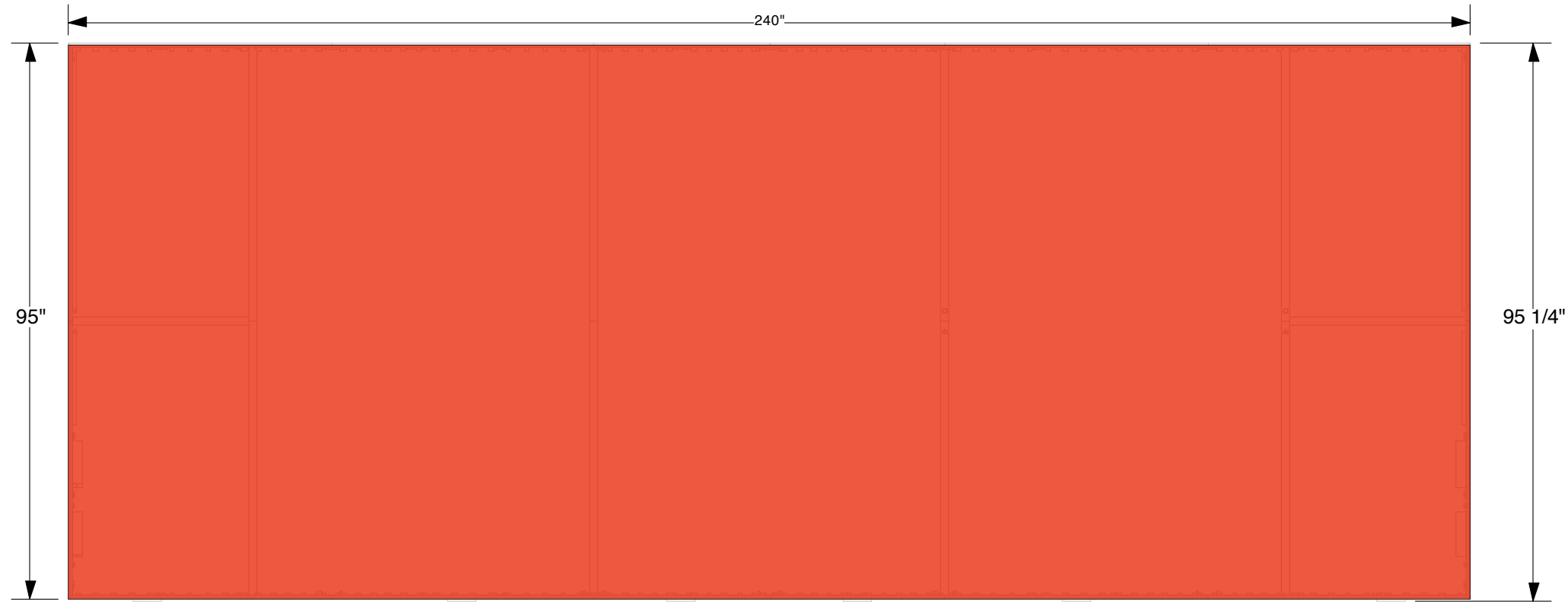

FRONT VIEW

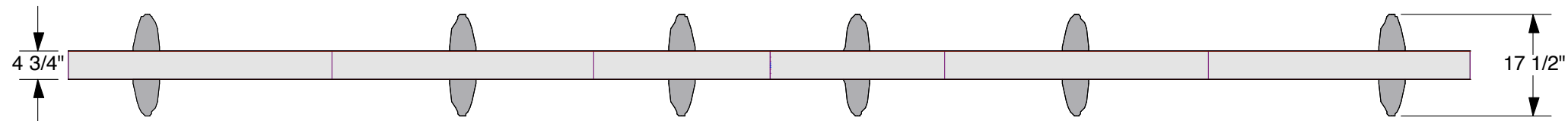

TOP VIEW

| Profile | Label | # | Description |
|---------|-------|----|--|
| | 001 | 6 | 1/4" ALUMINIUM OVAL BASE PLATE 17.5" (444.5mm) x 4.72" (120mm) |
| | 002 | 1 | M1901 - 45" (1143mm) EXTRUSION W/ (1) 45° CUT, (2) HOLES FOR BASE PLATE & LIGHTS |
| | 003 | 1 | M1901 - 45" (1143mm) EXTRUSION W/ (2) HOLES FOR BASE PLATE & LIGHTS |
| | 004 | 1 | M1901 - 30" (762mm) EXTRUSION W/ (2) HOLES FOR BASE PLATE & LIGHTS |
| | 005 | 1 | M1901 - 30" (762mm) EXTRUSION W/ (2) HOLES FOR BASE PLATE & LIGHTS |
| | 006 | 1 | M1901 - 45" (1143mm) EXTRUSION W/ (2) HOLES FOR BASE PLATE & LIGHTS |
| | 007 | 1 | M1901 - 45" (1143mm) EXTRUSION W/ (1) 45° CUT, (2) HOLES FOR BASE PLATE & LIGHTS |
| | 008 | 1 | M1901 - 47.5" (1206.5mm) EXTRUSION W/ (1) 45° CUT, PLASTIC EXTR. & POWER SUPPLY |
| | 009 | 1 | M1901 - 47.5" (1206.5mm) EXTRUSION W/ (1) 45° CUT & PLASTIC EXTRUSION |
| | 010 | 1 | M1901 - 45" (1143mm) EXTRUSION W/ (1) 45° CUT & LIGHTS |
| | 011 | 1 | M1901 - 45" (1143mm) EXTRUSION W/LIGHTS |
| | 012 | 1 | M1901 - 30" (762mm) EXTRUSION W/LIGHTS |
| | 013 | 1 | M1901 - 30" (762mm) EXTRUSION W/LIGHTS |
| | 014 | 1 | M1901 - 45" (1143mm) EXTRUSION W/LIGHTS |
| | 015 | 1 | M1901 - 45" (1143mm) EXTRUSION W/ (1) 45° CUT & LIGHTS |
| | 016 | 1 | M1901 - 47.5" (1206.5mm) EXTRUSION W/ (1) 45° CUT & PLASTIC EXTRUSION |
| | 017 | 1 | M1901 - 47.5" (1206.5mm) EXTRUSION W/ (1) 45° CUT, PLASTIC EXTR. & POWER SUPPLY |
| | 018 | 1 | Z4400 - 30.22" (767.6mm) EXTRUSION W/ (2) TENSION LOCKS |
| | 019 | 1 | Z4400 - 46.88" (1190.6mm) EXTRUSION W/ (1) TENSION LOCKS |
| | 020 | 1 | Z4400 - 46.88" (1190.6mm) EXTRUSION W/ (1) TENSION LOCKS |
| | 021 | 1 | Z4400 - 46.88" (1190.6mm) EXTRUSION W/ (1) TENSION LOCKS |
| | 022 | 1 | Z4400 - 46.88" (1190.6mm) EXTRUSION W/ (1) TENSION LOCKS |
| | 023 | 1 | Z4400 - 46.88" (1190.6mm) EXTRUSION W/ (1) TENSION LOCKS |
| | 024 | 1 | Z4400 - 46.88" (1190.6mm) EXTRUSION W/ (1) TENSION LOCKS |
| | 025 | 1 | Z4400 - 46.88" (1190.6mm) EXTRUSION W/ (1) TENSION LOCKS |
| | 026 | 1 | Z4400 - 46.88" (1190.6mm) EXTRUSION W/ (1) TENSION LOCKS |
| | 027 | 1 | Z4400 - 30.22" (767.6mm) EXTRUSION W/ (2) TENSION LOCKS |
| | | 8 | Z966 90° CORNER INTERNAL CONNECTOR |
| | | 28 | Z967 STRAIGHT INTERNAL CONNECTOR |
| | | 12 | 5/16-18 FLAT HEAD SCREW 0.75" LONG FOR BASE PLATES |
| | | 2 | 240"W (6096mm) x 95"H (2413mm) DYESUB GRAPHIC W/ SEG WELT ALL 4 SIDES |

GRAPHIC
Extrusion fabric groove

fabric graphic w/silicon edge

Insert the silicon edge of the fabric into the groove of the extrusions.

Start on the corners, then centers and work your way to corners from center on both directions.

To pull fabric graphic out of extrusion groove use pull tab on corner.

WALL ASSEMBLY (OPTIONAL)

Attach wall bracket to top extrusion groove with provided hammerhead screws. Locate position of wall bracket on extrusion (preferably by wood stud) by sliding the bracket on the extrusion and tighten it. Secure the frame to the wall with provided wood screw.

ULTRAFORM CASE #1
10'W x 8'H Configuration



END VIEW

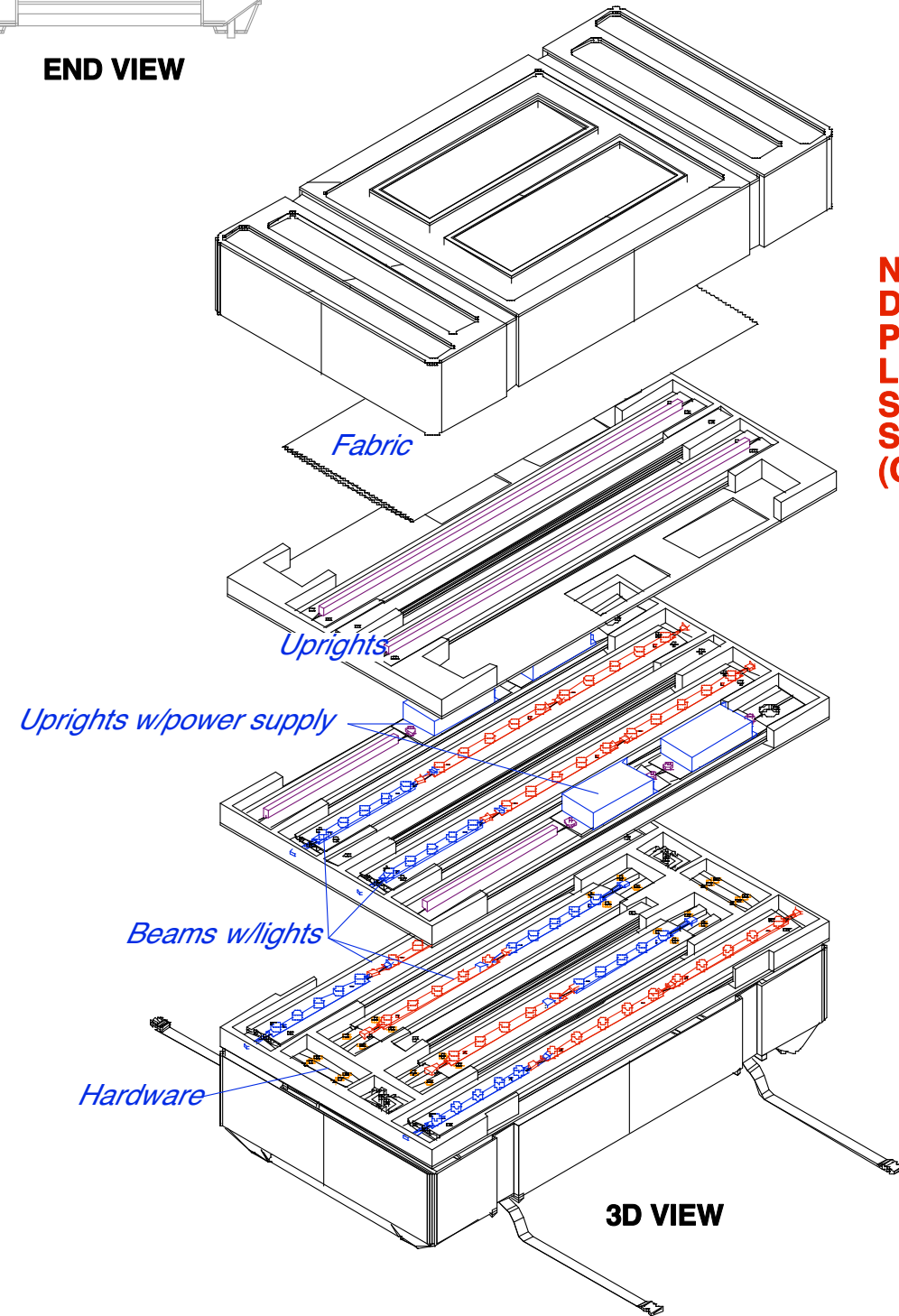

3D VIEW

ULTRAFORM CASE #2
20'W x 8'H Configuration



END VIEW

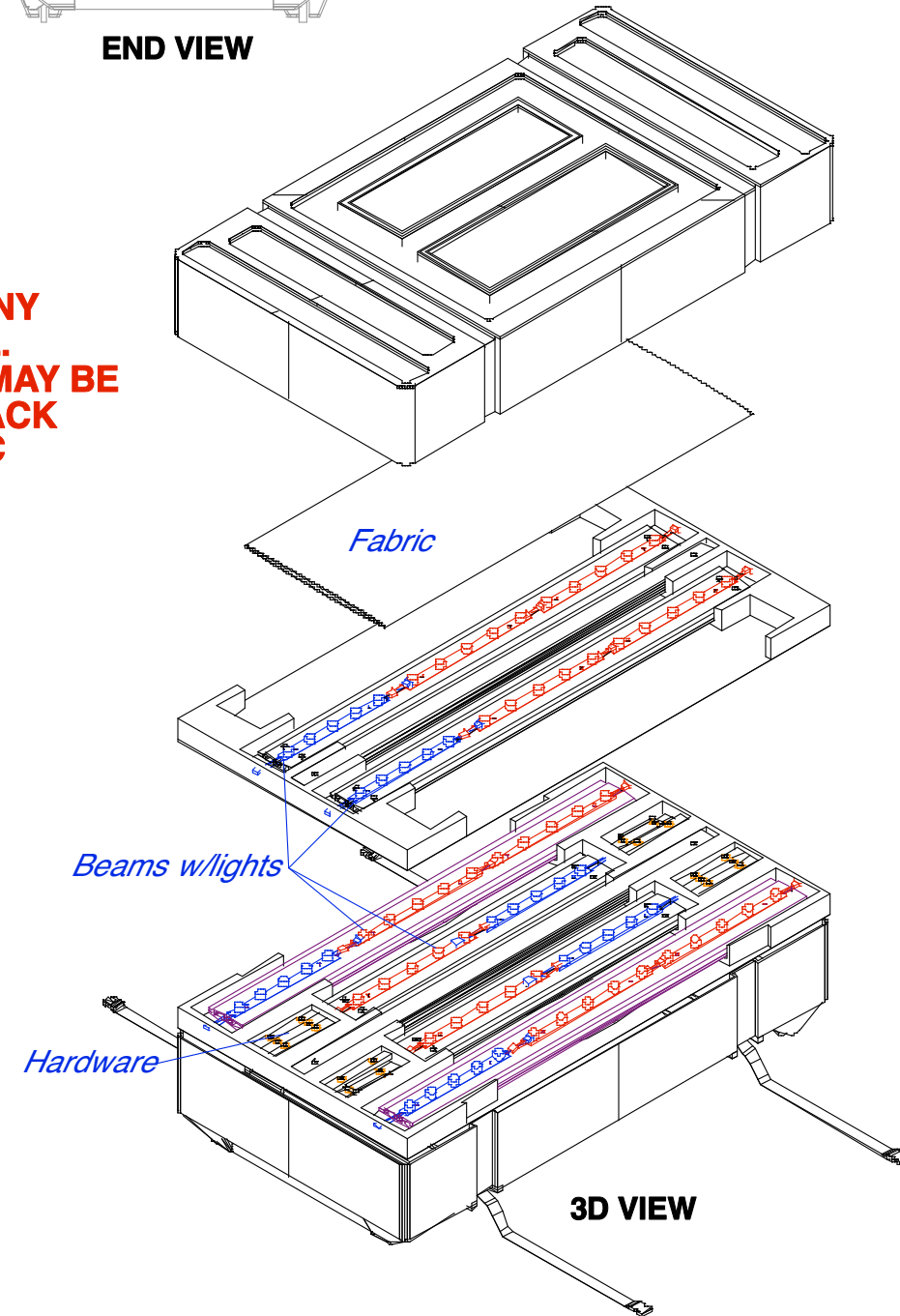

3D VIEW

NOTE:
DO NOT DISCARD ANY
PACKING MATERIAL.
LEVELS OF PARTS MAY BE
SEPARATED BY BLACK
SHEETS OF PLASTIC
(COROPLAST).

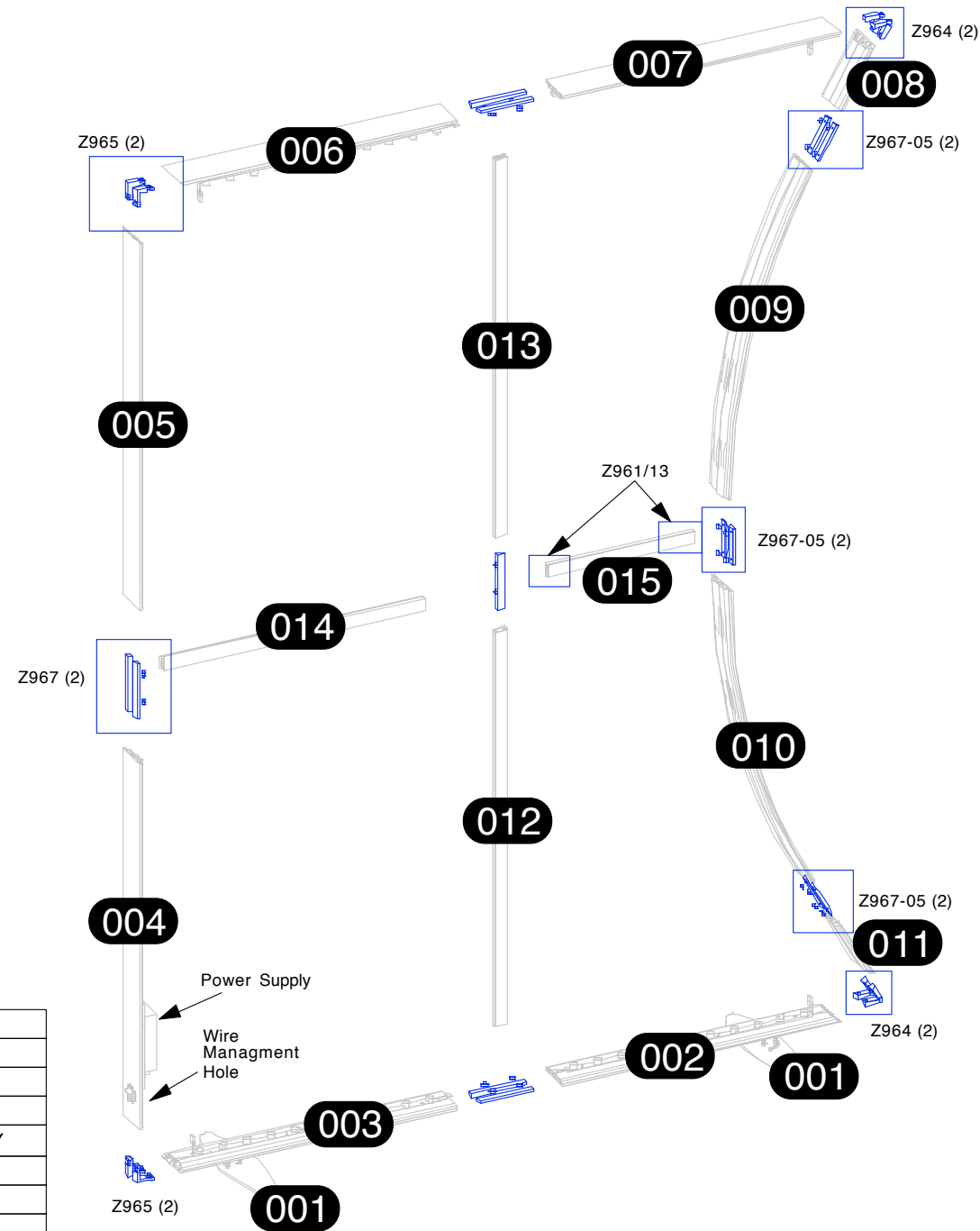
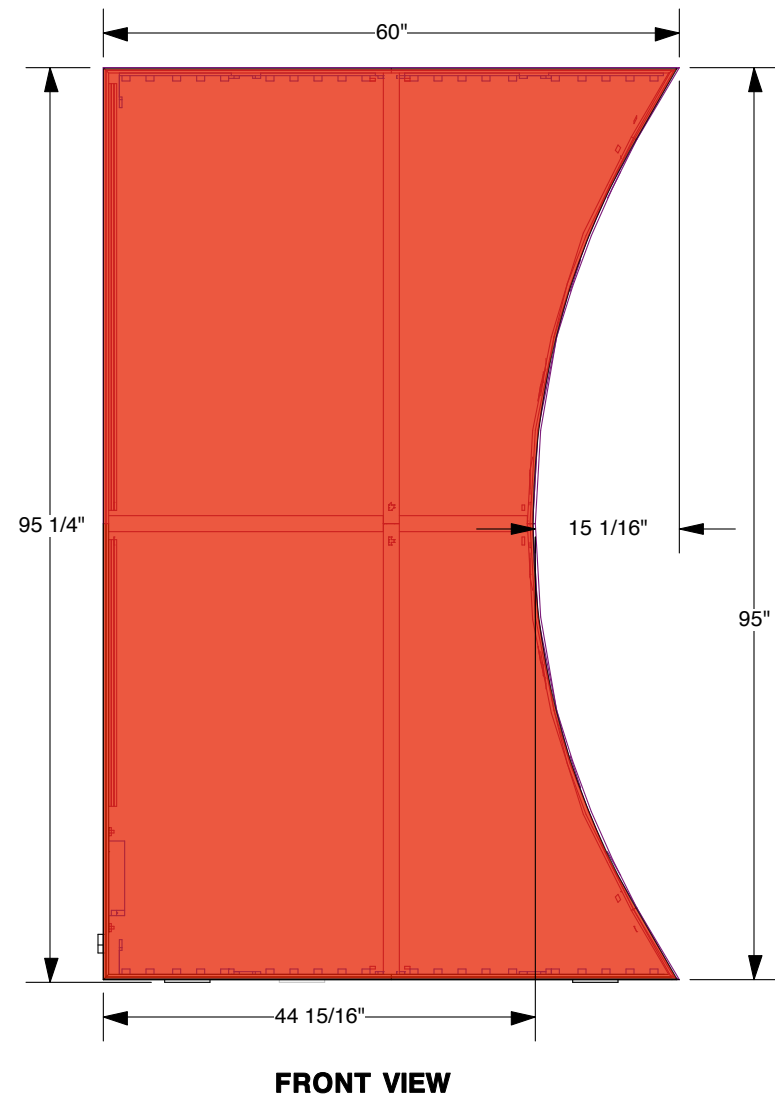

| Profile | Label | # | Description |
|---------|-------|---|--|
| | 001 | 2 | 1/4" ALUMINIUM OVAL BASE PLATE 17.5" (444.5MM) x 4.72" (120MM) |
| | 002 | 1 | M1901 30" (762 MM) EXTRUSION W/30° & (2) HOLES FOR BASE PLATE & LIGHTS |
| | 003 | 1 | M1901 30" (762 MM) EXTRUSION W/45° & (2) HOLES FOR BASE PLATE & LIGHTS |
| | 004 | 1 | M1901 47.5" (1206.5 MM) EXTRUSION W/ (1) 45° CUT, PLASTIC EXTR. & POWER SUPPLY |
| | 005 | 1 | M1901 47.5" (1206.5 MM) EXTRUSION W/ (1) 45° CUT, PLASTIC EXTR |
| | 006 | 1 | M1901 30" (762 MM) EXTRUSION W/45° & LIGHTS |
| | 007 | 1 | M1901 30" (762 MM) EXTRUSION W/30° & LIGHTS |
| | 008 | 1 | M1901 8.66" (200 MM) EXTRUSION W/ (1) 30° CUT |
| | 009 | 1 | M1901 60" (1524 MM) RADIUS CURVED EXTRUSION |
| | 010 | 1 | M1901 60" (1524 MM) RADIUS CURVED EXTRUSION |
| | 011 | 1 | M1901 8.66" (200 MM) EXTRUSION W/ (1) 30° CUT |
| | 012 | 1 | Z4400 46.88" (1190.6 MM) EXTRUSION W/ (1) TENSION LOCK & SPLICE HOLE |
| | 013 | 1 | Z4400 46.88" (1190.6 MM) EXTRUSION W/ (1) TENSION LOCK & SPLICE HOLE |
| | 014 | 1 | Z4400 28.59" (726.3 MM) EXTRUSION W/ (2) TENSION LOCK |
| | 015 | 1 | Z4400 13.5" (342.9 MM) EXTRUSION W/ (2) TENSION LOCK |
| | | 4 | Z965 90° CORNER INTERNAL CONNECTOR |
| | | 4 | Z964 ADJUSTABLE ANGLE CORNER INTERNAL CONNECTOR |
| | | 7 | Z967 STRAIGHT INTERNAL CONNECTOR |
| | | 6 | Z967-05 STRAIGHT INTERNAL CONNECTOR FOR CURVED EXTRUSION |
| | | 4 | 5/16-18 FLAT HEAD SCREW 0.75" LONG FOR BASE PLATES |
| | | 2 | 60"W (1524 MM) x 95"H (2413 MM) DYESUB GRAPHIC W/ SEG WELT ALL 4 SIDES |

1. Slide straight connector (Z967 & Z967-05) into inner channel of extrusion. Turn screw enough to hold connector in place.
2. Take another extrusion and slide onto straight connector. Tighten both screws to connect extrusions together.
3. Repeat above steps to connect all spliced extrusions together.
4. Slide corner connector (Z966 & Z964) into both sides of horizontal extrusions. Turn each screw enough to hold connector in place.
5. Slide vertical extrusions onto corner connectors of top horizontal extrusion. Turn each screw enough to hold connector in place.
6. Finish frame assembly by sliding corner connectors of bottom horizontal extrusion into inner channel of vertical extrusions and tighten the screws to secure frame extrusions together.

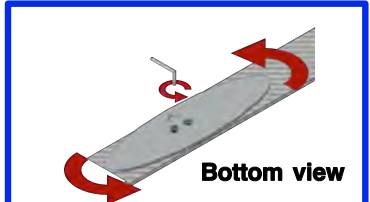

Loosen the screws on base plate but do not remove them. Then swivel base plates.

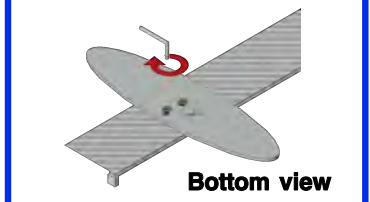

Tighten both screw firmly.

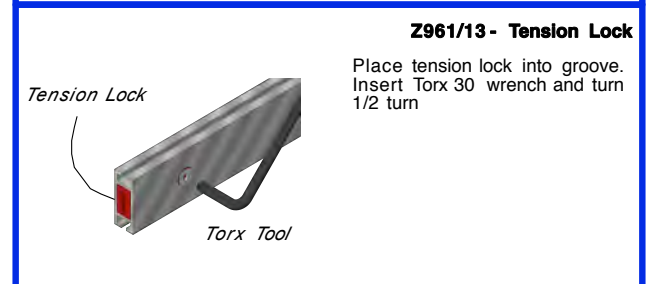
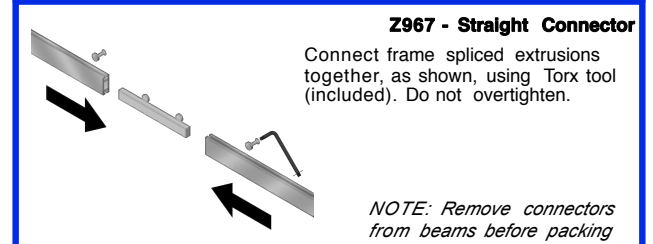
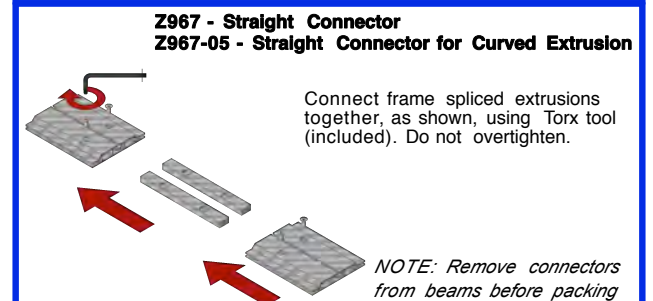
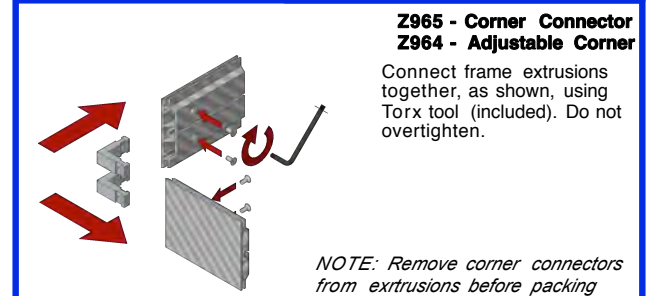

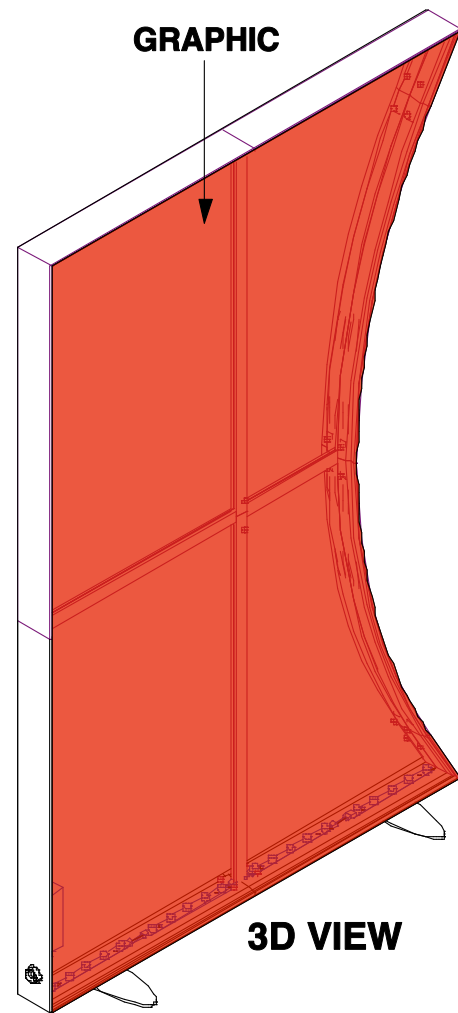

3D VIEW

GRAPHIC

Extrusion fabric groove

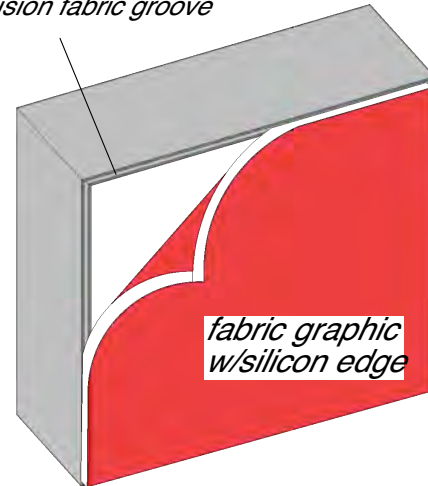

Insert the silicon edge of the fabric into the groove of the extrusions.

Start on the corners, than centers and work your way to corners from center on both directions.

To pull fabric graphic out of extrusion groove use pull tab on corner.

WALL ASSEMBLY (OPTIONAL)

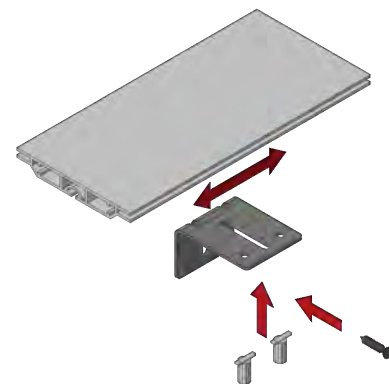

Attach wall bracket to top extrusion groove with provided hammerhead screws. Locate position of wall bracket on extrusion (preferably by wood stud) by sliding the bracket on the extrusion and tighten it. Secure the frame to the wall with provided wood screw.

LIGHTS DETAILS

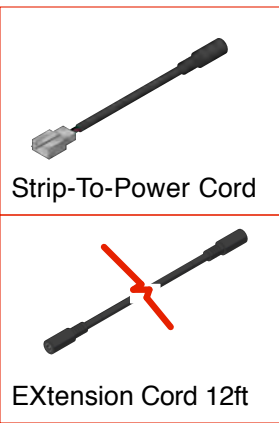
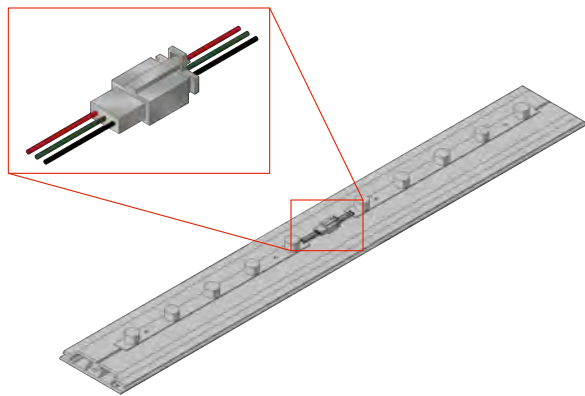

Lights come attached to extrusions. Ensure all lighting strips are connected. Once frame is assembled, connect strip-to-power cords to the end of top and bottom lights chain.

- For bottom lights connect strip-to-power cord to power supply directly.
- For top lights connect extension cord to strip-to-power cord and run with wire management extrusion then connect to power supply.

Run AC power cord out through grommet hole on vertical upright and connect to power outlet.

To remove or re-attach light strips use provided thumbscrews with plate.

PACKING DIAGRAM



**NOTE:
DO NOT DISCARD
ANY PACKING
MATERIAL.
LEVELS OF PARTS
MAY BE
SEPARATED BY
WHITE SHEETS OF
PLASTIC,
COROPLAST OR
CARDBOARD.**

