

Monitor Mount

BLM-TV-40-K

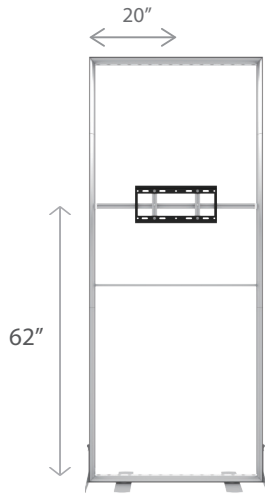

PRODUCT DESCRIPTION

Designed for compatibility with BrightLine and StraightLine Displays, these mounts deliver a captivating "floating" screen sensation. Simply slide the TV bar into the frame, secure the monitor plate with screws, and attach your screen on the front. Side feet are included in the kit for extra stability. Graphics can be finished with four small pre-cut slits for convenient access, or you can customize your own cutouts as required.

MONITOR SPECIFICATIONS

Holds monitors up to 25 lbs, VESA 200 X 200

PARTS

(1x) Allen Key



(4x) Bracket-to-Monitor Screws:
M5, M6, & M8 screws included.
Check your TV for specs



(1x) Philips Screwdriver



Monitor Plate



TV Bar 40"



Monitor Brackets
(2)



Side Foot
(2)

Monitor Mount

BLM-TV-40-K

BrightLine

StraightLine

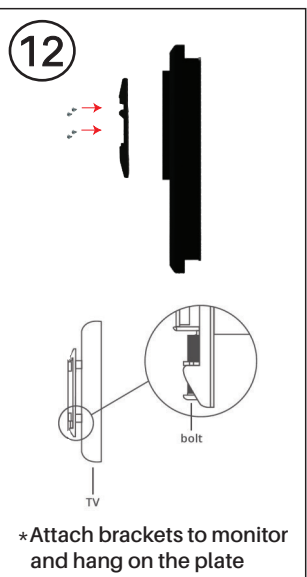
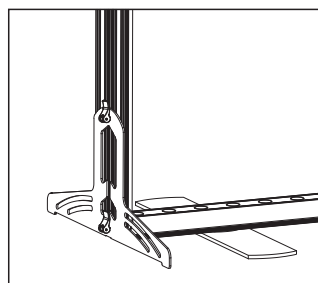
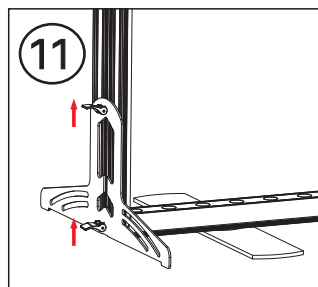
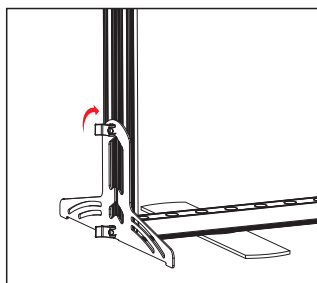
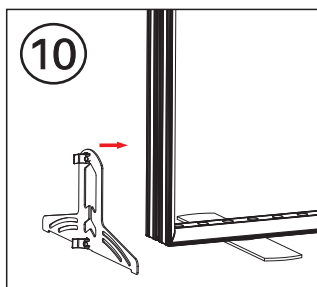
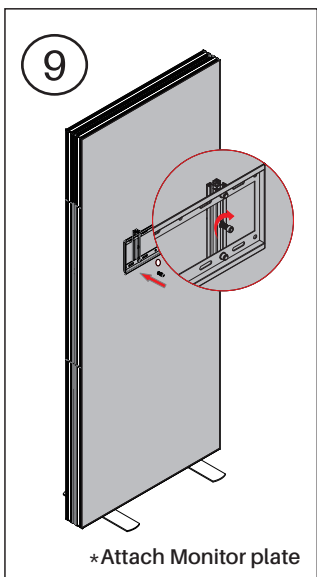
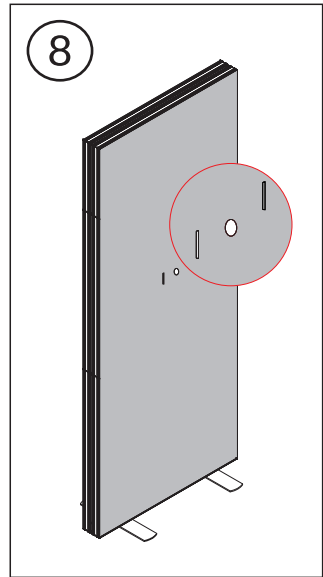
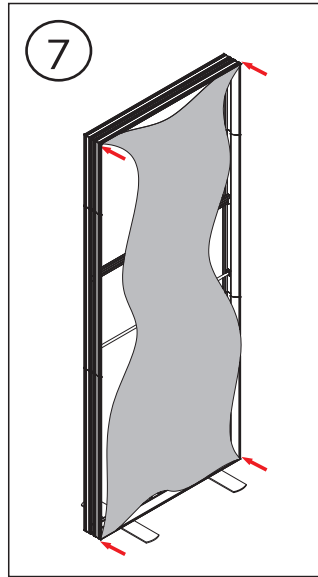
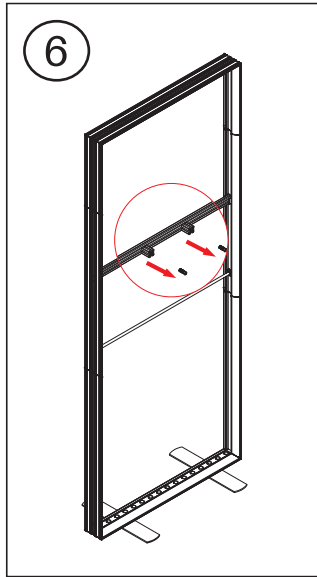
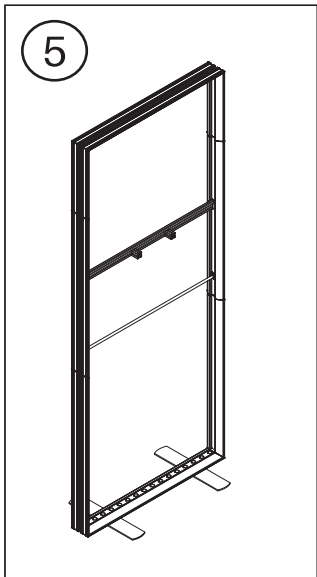
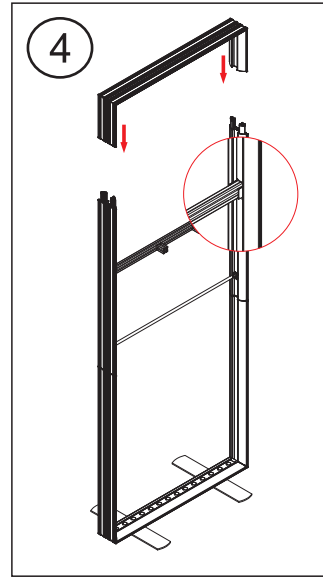
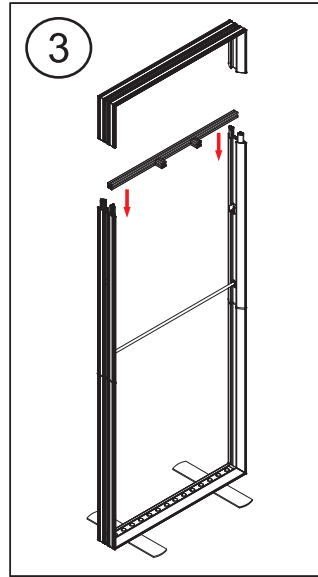
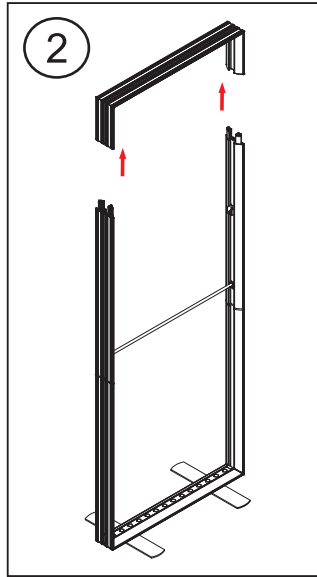

PARTS INCLUDED

Adhesive Cable Clips (4x)



Reusable Velcro Cable Ties (5x)



Resealable Lock Bag



You will need 10ft Extension Cable

1

Connect the extension cable to your TV. Route cable inside the groove of the TV bar and use cable ties to secure in place.

2

Attach wire clips to the frame. Then route the cable through and secure within the clips.

3

Route cable through the bottom corner of the frame.

4

Secure the vertical end of the graphic first, adjust cable, then finish with the bottom of the fabric