

LUMIWALL LED Backlit fabric display

LUMIWALL is constructed of aluminum extrusion and features SEG press fit fabric graphics for hassle free set up. Heavy duty aluminum feet ensure maximum stability. Graphics are printed on premium fabric designed to provide maximum illumination while maintaining vibrant colors. The entire unit disassembles and packs flat in a single wheeled rotomolded case for unparalleled protection.

MODEL #: LW-36

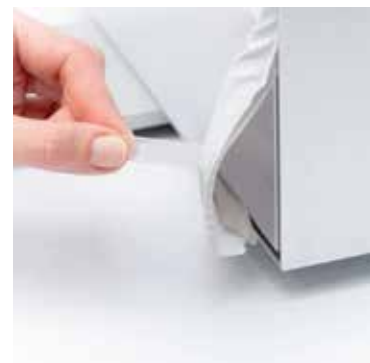
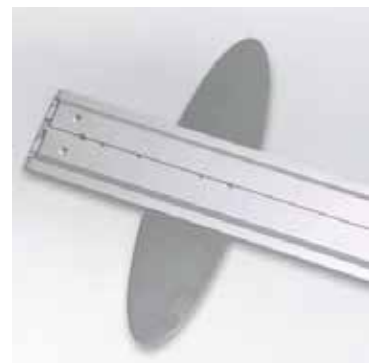
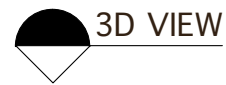

Details

- Aluminum Extrusion Frame
- Single or double-sided SEG press fit dye-sublimated fabric graphics
- Easy assembly
- Packs in a single 4825 rotomolded wheeled, flat transport case
- Limited Lifetime Warranty
- Made in the USA

Includes

- 3' x 6' Lumiwall Frame
- Lumiwall Stabilizer Feet
- Backlit Front Fabric
- White Backing Fabric
- LED Backlighting Kit (800 Lumens, 6500k Daylight White)
- Lumiwall Tool Kit
- Rotomolded Case

Dimensions

Assembled unit:
36" w x 72" h x 17.5" d
50 lbs / 22.7 kgS

Graphic area:
35 13/16" w x 71 13/16" h

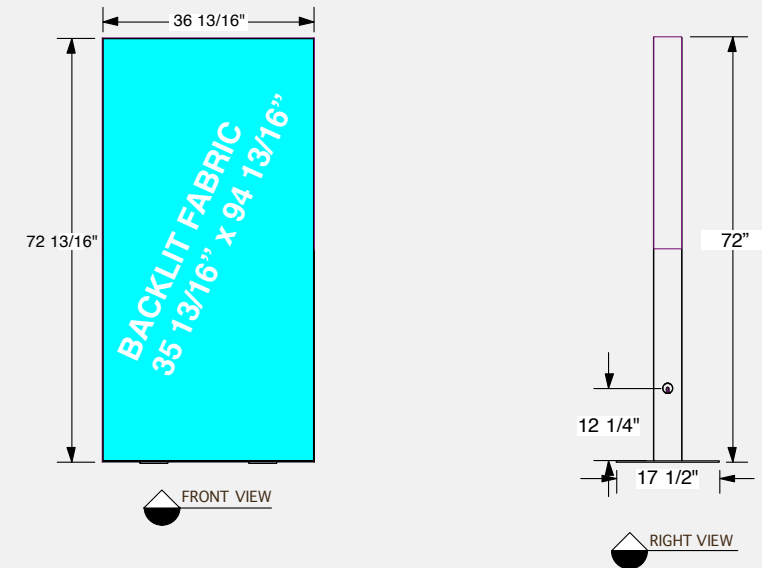

Additional information

Power/Wattage Requirements: 40w
Set-Up Time: 25-30min
Lead Time: 10 Days
Warranty: Limited Lifetime Warranty

Shipping



Packs in (1) 4325 case
Shipping dimensions:
44" h x 27" w x 7" d
1118mm x 685mm x 178mm
50 lbs / 22.7 kgS

LW-36 PACKAGE CONTENTS

Profile	Label	#	Description
	001	2	1/4" ALUMINIUM OVAL BASE PLATE 17.5" (444.5MM) x 4.72" (120MM)
	002	1	M1901 36" (914.4MM) EXTRUSION W/ (2) 45° CUTS, (4) HOLES FOR BASE PLATE & LIGHTS
	003	1	M1901 36" (914.4MM) EXTRUSION W/ (1) 45° CUT
	004	1	M1901 36" (914.4MM) EXTRUSION W/ (1) 45° CUT
	005	1	M1901 36" (914.4MM) EXTRUSION W/ (1) 45° CUT, PLASTIC EXTR. & POWER SUPPLY
	006	1	M1901 36" (914.4MM) EXTRUSION W/ (1) 45° CUT & PLASTIC EXTR.
	007	1	M1901 36" (914.4MM) EXTRUSION W/ (2) 45° CUTS & LIGHTS
	008	1	Z4400 34.75" (882.7MM) EXTRUSION W/ (2) LOCKS
	8		Z966 90° CORNER INTERNAL CONNECTOR
	4		Z967 STRAIGHT INTERNAL CONNECTOR
	4		5/16-18 FLAT HEAD SCREW 0.75" LONG FOR BASE PLATES
	2		35.5"W (908MM) x 71.5"H (1816MM) SINGLE SIDED DYESUB GRAPHIC W/ SEG WELT ALL 4 SIDES

2. GRAPHIC

Insert the silicon edge of the fabric into the groove of the extrusions.

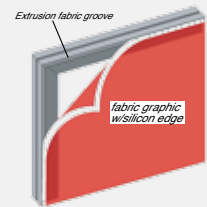

Start on the corners, then centers and work your way to corners from center on both directions.

To pull fabric graphic out of extrusion groove, use pull tab on corner

3. LIGHT ASSEMBLY

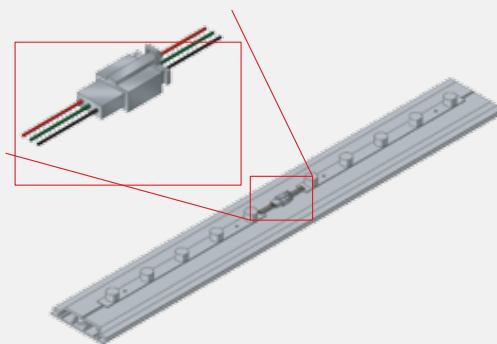

Lights come attached to extrusions. Ensure all lighting strips are connected. Once frame is assembled, connect strip-to-power cords to the end of top and bottom lights chain.

- For bottom lights connect strip-to-power cord to power supply directly.
- For top lights connect extension cord to strip-to-power cord and run with wire management extrusion then connect to power supply.

Run AC power cord out through grommet hole on vertical upright and connect to power outlet.
To remove or re-attach light strips use provided thumbscrews with plate

1.

- Slide straight connector (Z967) into inner channel of extrusion. Turn screw enough to hold connector in place.
- Take another extrusion and slide onto straight connector. Tighten both screws to connect extrusions together.
- Repeat above steps to connect all spliced extrusions together.
- Slide corner connector (Z966) into both sides of horizontal extrusions. Turn each screw enough to hold connector in place.
- Slide vertical extrusions onto corner connectors of top horizontal extrusion. Turn each screw enough to hold connector in place.
- Slide vertical extrusions onto corner connectors of bottom horizontal extrusion into inner channel of vertical extrusions and tighten the screws to secure frame extrusions together.

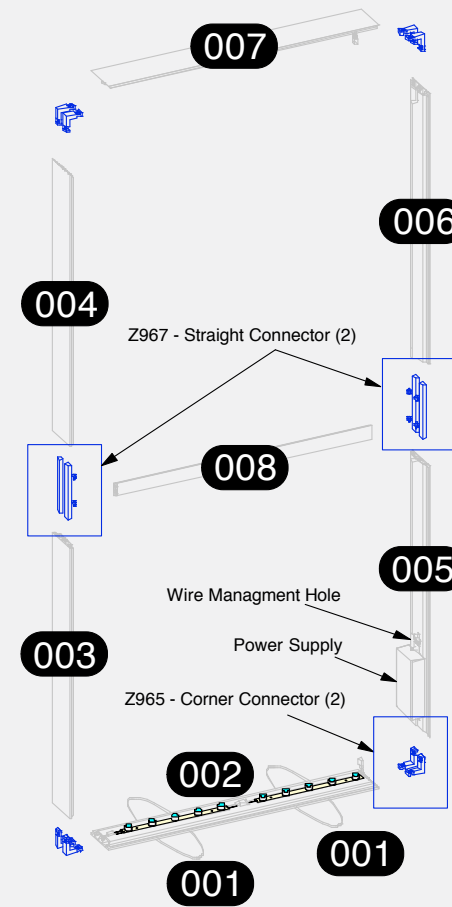

Connect frame extrusions together, as shown, using Torx tool (included). Do not overtighten.

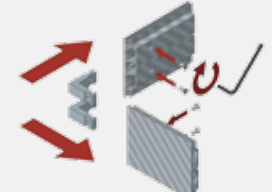

NOTE: Remove corner connectors from extrusions before packing.

Connect frame spliced extrusions together, as shown, using Torx tool (included). Do not overtighten.

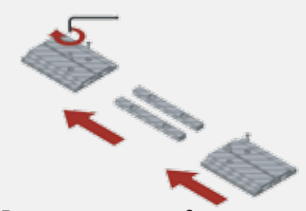

NOTE: Remove connectors from extrusions before packing

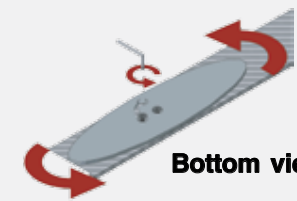

Loosen the screws on base plate but do not remove them. Then swivel base plates.



Tighten both screw firmly.

4. WALL MOUNT (Optional)

Attach wall bracket to top extrusion groove with provided hammerhead screw. Locate position of wall bracket on extrusion (preferably by wood stud) by sliding the bracket on the extrusion and tighten it. Secure the frame to the wall with provided wood screw.

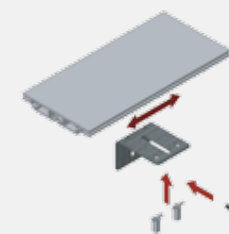

PACKING DIAGRAM

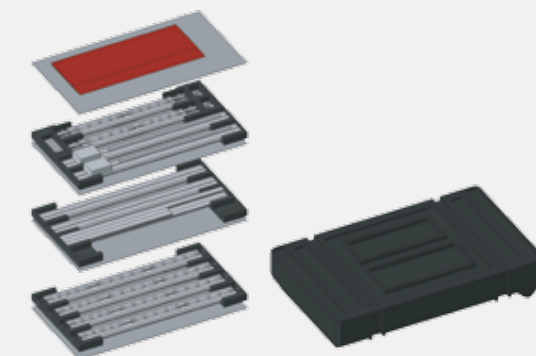



10x8



8x8

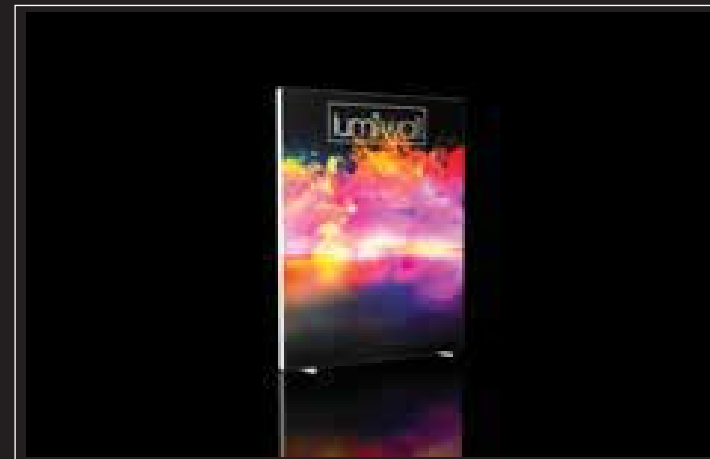

6x8

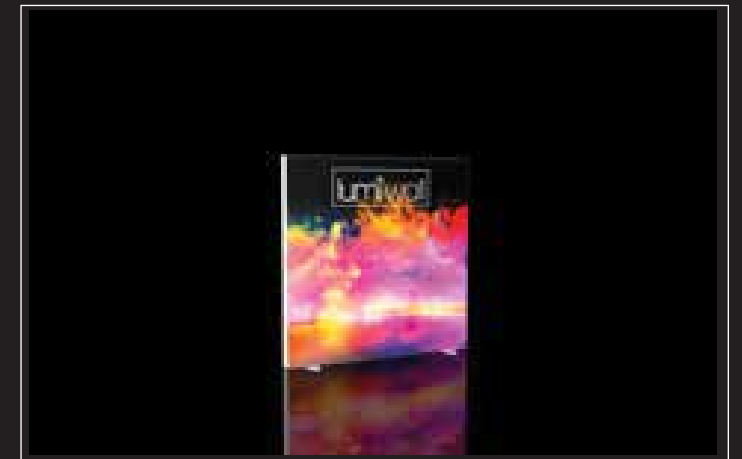

6x6

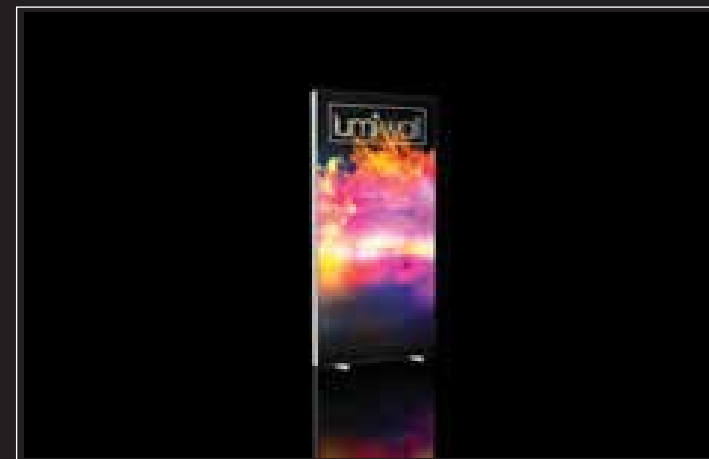

4x8

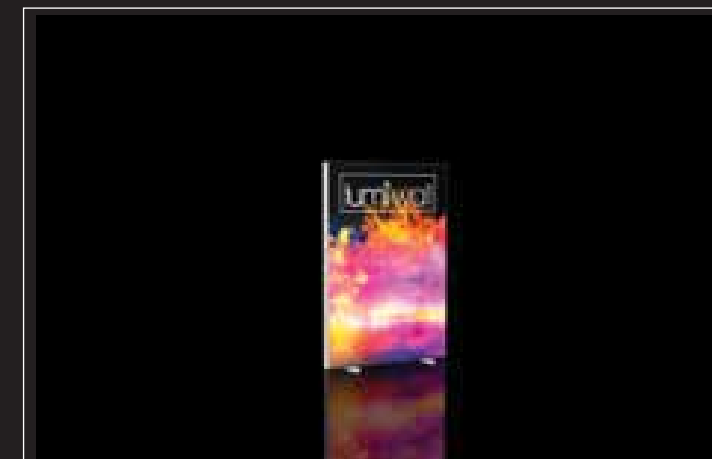

4x6

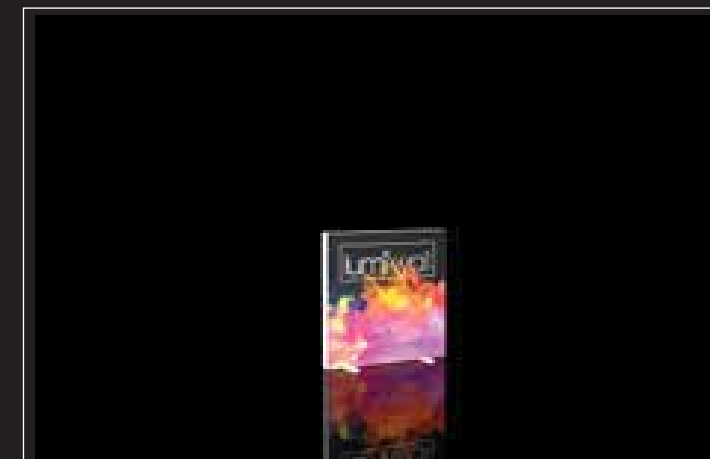

4x4



3x8

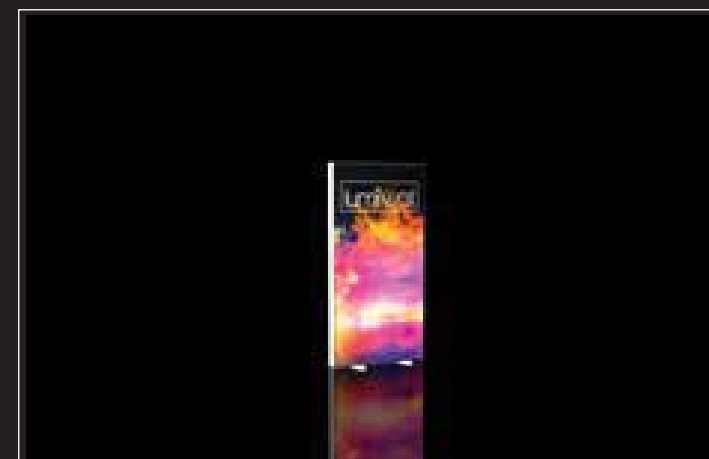

3x6

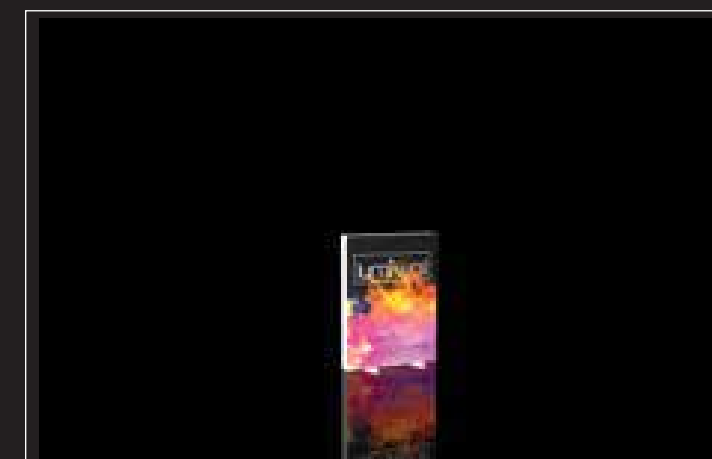

3x4

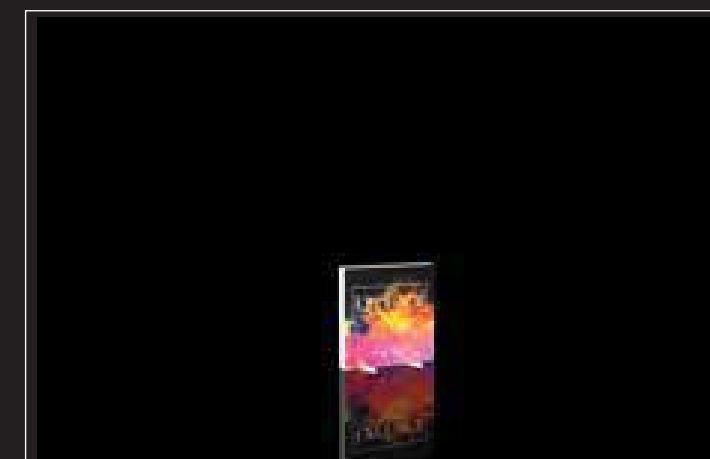

3x3